

Countertop Items 500, 502, 503, 550, 552, 553, 600, 602, 603, 650, 652 & 653

Rectangular Front Countertop

for Single Round Basin	Item No. 500
for Double Round Basin	Item No. 502
for Triple Round Basin	Item No. 503
for Single Oval Basin	Item No. 550
for Double Oval Basin	Item No. 552
for Triple Oval Basin	Item No. 553

Radius Front Countertop

for Single Round Basin	Item No. 600
for Double Round Basin	Item No. 602
for Triple Round Basin	Item No. 603
for Single Oval Basin	Item No. 650
for Double Oval Basin	Item No. 652
for Triple Oval Basin	Item No. 653

For Vitraform Freestanding Bowls or bowls provided by other.
Contact Factory for approval of non Vitraform basins in this application.

Available in any width from 20"(508) to 84" (2134) with radius or rectangular front and custom shapes.

Specify flat polished or pencil edge to coordinate with edge of basin.

Shop drawings are provided by the factory to coordinate basin, countertop, faucet and installation requirements.

See Hardware Specification pgs B.2.2-12 for Vitraform Counter Top mounting systems.

Order bowl separately.

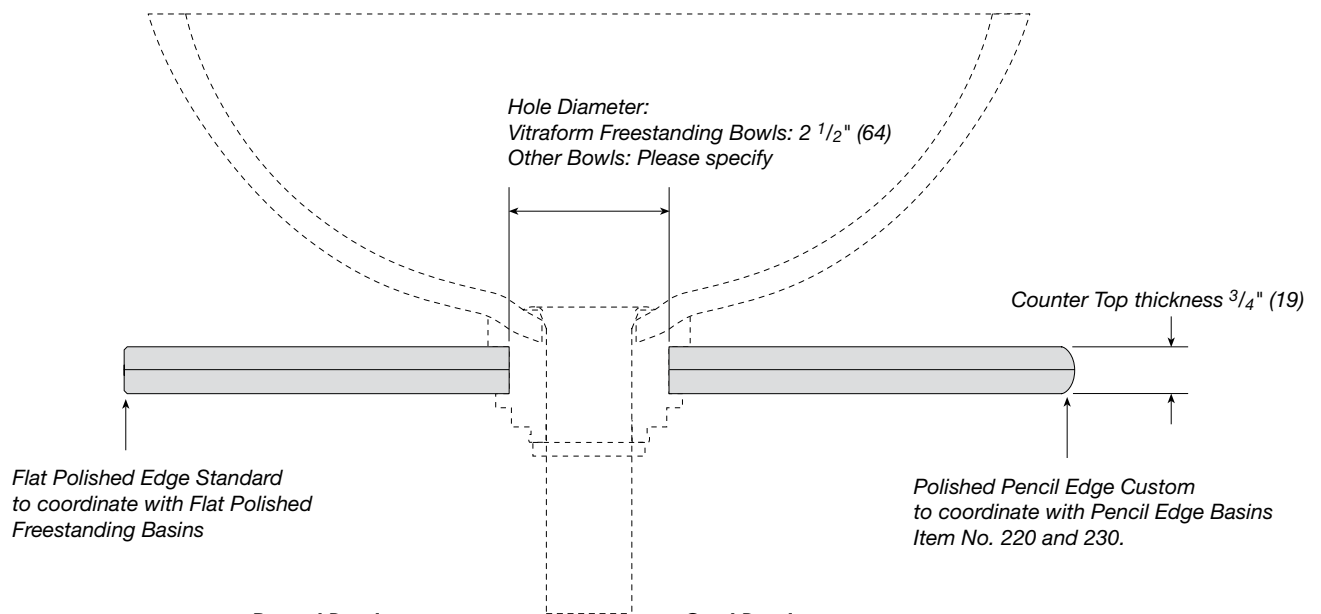

Round Bowls:

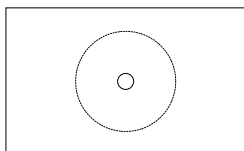

Rectangular Front Item No. 500

Oval Bowls:

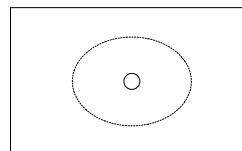

Rectangular Item No. 550

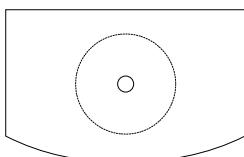

Radius Front Item No. 600

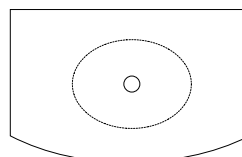

Radius Front Item No. 650

Overview of standard sizes for Countertops for Vitraform Freestanding Round or Oval Basins.

Items 500, 502, 503, 550, 552, 553, 600, 602, 603, 650, 652 & 653

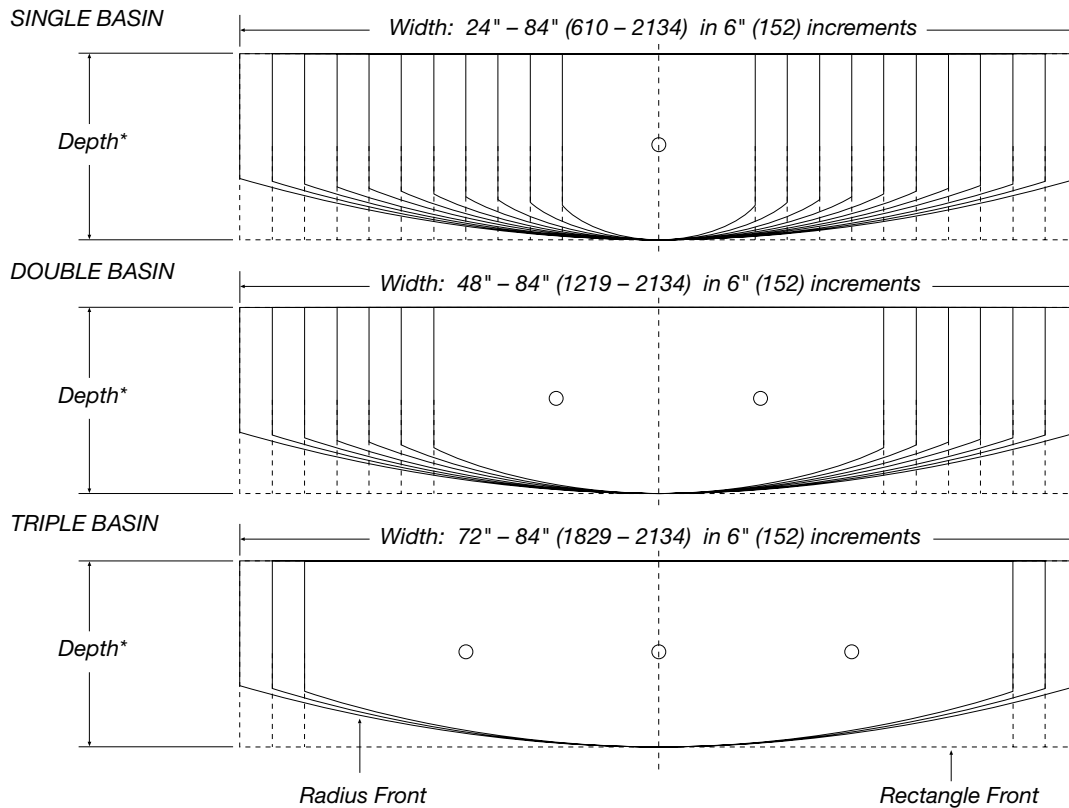

* Depth of countertop ranges from 19" to 23" depending on size of basin and faucet selection.

NOTES:

Standard configurations shown above provide a general overview for planning, size and faucet projection using Vitraform Freestanding basins.

All Vitraform Countertops are made to specification, including unusual shapes, off center cutout holes for basins, holes for deck-mounted faucets and other site specific requirements. Drawings for approval are provided by the factory to include installation details and coordination of faucet specification.

Contact factory for approval of basins "by other" to be used with Vitraform Countertops.

Prices are by size, color and number and size of holes regardless of the shape the counter. Due to the endless options for coordination of deck or wall faucet, shape and size of sink, size of counter and site requirements, contact factory for assistance.

Countertops are also offered with cutout for Round, Oval or Rectangular bowls for under mount or drop-in installations on page 5.1.4.

Mounting systems for Countertops are shown on pg B.2.2-12 of the Hardware section.

Overview of standard sizes for Countertops for Round, Oval or Rectangular Vitraform Undermount or Drop-in basins.

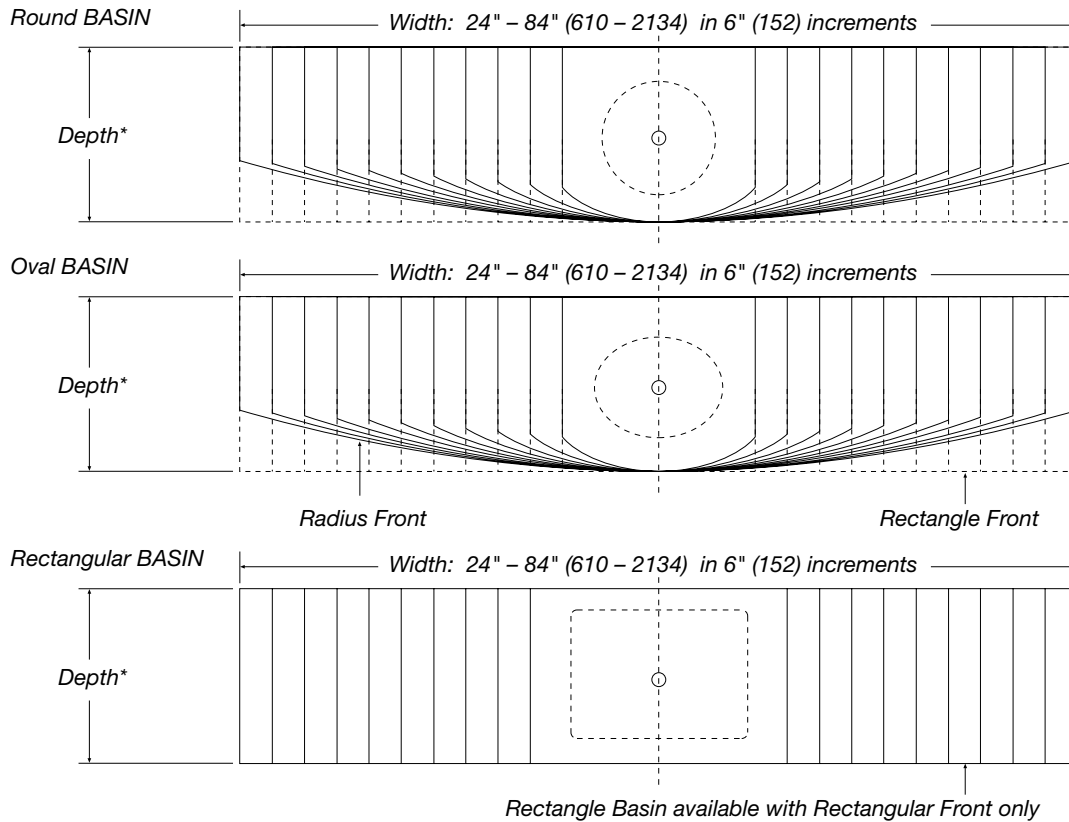

* Depth of countertop ranges from 25" depending on size of basin and faucet selection.

NOTES:

Standard configurations shown above provide a general overview for planning, size and faucet projection using Vitraform Undermount or Drop-in basins.

All Vitraform Countertops are made to specification, including unusual shapes, off center cutout holes for basins, holes for deck-mounted faucets and other site specific requirements. Drawings for approval are provided by the factory to include installation details and coordination of faucet specification.

Contact factory for approval of basins "by other" to be used with Vitraform Countertops. Prices are by size, color and number and size of holes regardless of the shape the counter. Due to the endless options for coordination of deck or wall faucet, shape and size of sink, size of counter and site requirements, contact factory for assistance.

Drawing examples above provide a simple overview of options for Vitraform CounterTops to support Under Mount or Drop-in basins. Shown are Vitraform single Round, Oval and Rectangular Standard Basins. Countertops are also offered with holes for Vitraform Round or Oval Freestanding bowls on page 5.1.3.

Mounting systems for Countertops are shown on pg B.2.2-12 of the Hardware section.

Countertop Handling Instructions

Please provide these instructions to contractor at point of sale.

All Vitraform glass products are manufactured using (2) layers of annealed non-tempered glass, which, like an automobile windshield are laminated together with a layer of plastic. If the glass breaks, the pieces will be held in place by the laminate layer. Vitraform products are very strong, but sensitive to hard object impact, extreme or rapid changes in temperature and high mechanical stress. Most damage to this product occurs during installation due to improper handling or over tightening of the plumbing hardware. VITRAFORM sinks are intended and Warranted for Lavatory use only.

Crating

Countertops are shipped from the factory in strong, custom built crates that are suitable for long term storage if necessary. The glass is captured at its edge and held in the crate in a vertical orientation. For shipping and storage this is the strongest orientation for glass. Upon receipt of the product the crate should be opened and inspected for hidden damage which may have occurred during shipping. Crates may be opened and resealed from the top and (1) side by unscrewing Phillips head screws. Upon acceptance of the product the crate should be resealed and carefully stored until the product is ready for installation.

Handling

As stated above, glass is best handled and transported in a vertical orientation which also applies to carrying the product while installing. For larger sizes (36" width and larger) it is best to keep the product vertical until it is finally installed. While installing, care should be taken to evenly support the glass to avoid over stressing it. This glass is most vulnerable at its edge so if it is necessary to stand it on its edge, make sure to do so on a clean, soft material such as carpet or foam rubber.

Protective Plastic Film

The product is shipped from the factory with a temporary protective plastic film on all surfaces. It is best to leave this protective film on the glass, peeling back only enough area for installation, and only removing it when the bathroom is finally ready to be used. This plastic is intended to prevent light abrasions during shipping but will not protect against severe abrasions that can occur on a construction site. It is the responsibility of the installer to add additional protection. If possible, it is recommended that Countertops be the last component in the bathroom to be installed, due to the nature of the material.

Scratches and Chips

Vitraform glass products may become scratched or chipped at installation or with use over time. Once installed it is extremely difficult to remove scratches from the product on site. Depending upon available local services and the severity of the damage it is possible to do minor repair on site. If possible, return the product to the factory for repair. Remember that the best way to deal with scratches is to prevent them entirely by treating the product like glass. Do not store heavy, hard objects above the product. Do not put hard objects such as other glass or ceramic objects directly on the product. Contact factory for assistance evaluating proper repair.

Cleaning

We recommend the use of common ammonia or alcohol based glass cleaners applied with a clean, soft cloth. Never use abrasive materials or cleansers; which can destroy the surface of the glass. Glass may become etched or water spotted due to minerals in the water. Avoid water spots by drying the product after use and following recommended cleaning procedure.

Silicone Adhesives

Where the use of Silicone Adhesive is needed for the installation of this product special precaution must be taken. Adhesives are virtually impossible to remove, especially on frosted and satin etched finishes, even before they set. Extreme care must be taken while handling Silicone Adhesive in conjunction with this product.

General Installation Note

Follow installation instructions provided with Vitraform mounting systems if applicable. For attachment to a vanity or other support, contact factory for assistance.

Worksheet for Items: 500, 502, 503, 550, 552, 553, 570, 572, 600, 602, 603, 650, 652 & 653

This Worksheet is provided for your convenience.

Please refer to the current Vitraform General Price List to build a complete item number and price for this product.

P.O. No: _____ Date: _____ Sales Person: _____ Tel: _____ Ext: _____

Glass Order	Quantity: _____ Please use additional Order Forms for non-identical orders.				
	Order No: _____	_____	_____	_____	_____
	A	B	C	D	E
Price: \$ _____	_____	_____	_____	_____	TOTAL \$ _____

The following information is required by the factory to provide a drawing for approval. Provide sink specifications if other than Vitraform.

Install Hardware	See Hardware Pages B.2.2 - B.2.12	
	Qty.	Item/Fin. #
	Mounting System _____	
Specify thickness of Wall finish for recessed installation:		

Faucet Specifications	Deck mount faucet	
	<input type="checkbox"/> Single Hole*	_____
	<input type="checkbox"/> Wide spread*	_____
	<input type="checkbox"/> Position in straight line	<input type="checkbox"/> Follow line of bowl
*For Deck mount faucets attach manufacturer's specifications for spout projection, escutcheon size and hole size(s).		
Wall mount faucet		
<input type="checkbox"/> Faucet Manufacturer and item number	_____	
*For Wall mount faucets attach manufacturer's specifications for spout projection, escutcheon size and hole size(s).		

Custom Options	Console Leg Specifications	
	Counter height (specify dimension):	
	Custom Counter	
	<input type="checkbox"/> Size: enter exact dimensions below	_____
Width: _____	Depth: _____	
<input type="checkbox"/> Pencil Edge	<input type="checkbox"/> Flat Polished Edge	
<input type="checkbox"/> Combination Flat and Pencil Edges (attach drawing)		
Attach rough drawing for position of bowl, shape of counter type of support and other details.		

Finish Key Call for quote on custom finishes.

Example:	Fin. Group 1 Code	Fin. Group 2 Code	Fin. Group 3 Code	Fin. Group 4 Code
Add 2 digit Finish Code to 3 digit Item No.	Polished Chrome 10	Polished Nickel 12	Oil Rubbed Bronze 15	Polished Gold 13
810.20 = Grid with US PTrap Satin Chrome		Satin Chrome 20	PVD Brass 16	Satin Gold 23
		Satin Nickel 22	Satin Brass 21	